

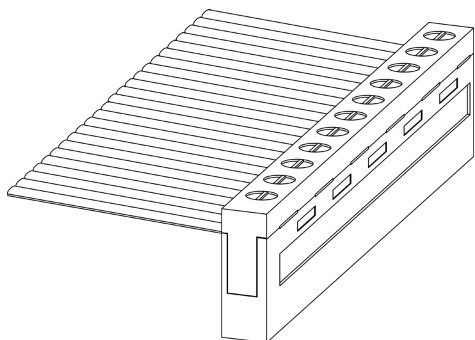

SRS (Single-Row-Socket) Jumper Selection Guide

Style No.: 39035



FEATURES and BENEFITS:

- Eliminates usual cable/connector assembling.
- Inseparable - nothing to come apart.
- Ultimate strain relief inherent in design.
- No pull tabs required; cable molded into connector.
- Eliminates usually exposed conductor ends.
- Single-row contacts on .100 in. (2,54 mm) centers.
- Line-by-line probe access holes are standard.
- Mate with single rows of .025 in (0,64 mm) square or round posts spaced on standard .100 in. (2,54 mm) centers.
- May be daisy chained onto .050 in (1,27 mm) and .100 in. (2,54 mm) pitch cable as well as combined with other IDC connector styles on .050 pitch cables.
- Insertable polarity keys are available.
- 100% factory testing of **each** jumper shipped.

SPECIFICATIONS:

Electrical:

Current rating:	1 amp (D.C.)
Dielectrical withstanding voltage:	1000 volts (sea level)

Physical:

Contact material:	CuNi18Zn20
Plating:	see Surface-Finish-Materials Table

Environmental:

Material:	U.L. rated 94 V-O
Operating temperature range:	-40°C to +105°C

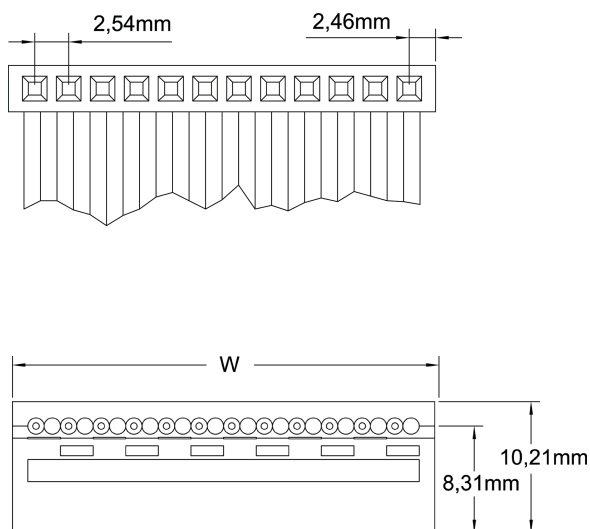
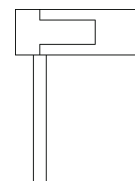
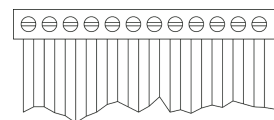

DIMENSIONS: in inch (mm)

Size	W
04	0.494 (12,55)
05	0.594 (15,09)
07	0.794 (20,17)
08	0.894 (22,71)
09	0.994 (25,25)
10	1.094 (27,79)
11	1.194 (30,33)
12	1.294 (32,87)
14	1.494 (37,95)
16	1.694 (43,03)
18	1.894 (48,11)
20	2.094 (53,19)
24	2.494 (63,35)
32	3.294 (83,67)

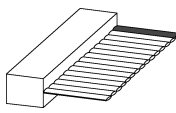
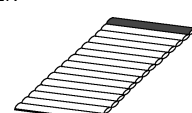
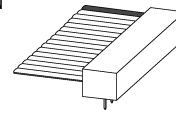
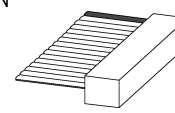
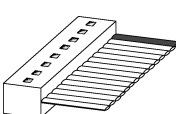
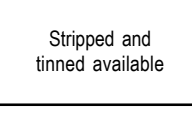
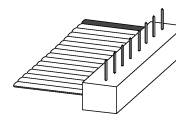
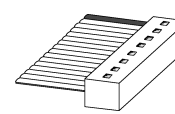
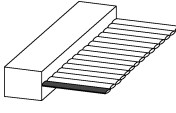
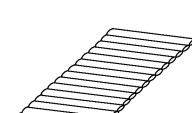
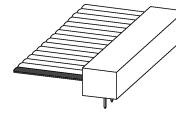
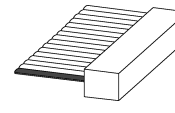
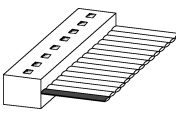
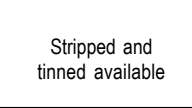
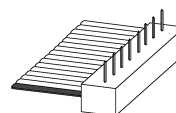
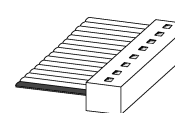

Ordering Information

LEFT-END...		RIGHT-END CONNECTOR STYLE NUMBERS	
SRS Style 39035	NO CONNECTOR Style 39000	SRB Style 39033	SRS Style 39035
DOWN 	OPEN 	DOWN 	DOWN 
UP 	Stripped and tinned available 	UP 	UP 
STRIPE UP			
DOWN 	OPEN 	DOWN 	DOWN 
UP 	Stripped and tinned available 	UP 	UP 
STRIPE DOWN			

Easy 4-Step Jumper Description - EXAMPLE

For detailed information please see Technical Informations

	LEFT CONTACTS	CONNECTOR STYLE NO.	CONTACT FINISH	CONNECTOR SIZE
STEP 1	Left up =LP Left down =LN Left Open =LO	LN 39035	01	20
STEP 2	RIGHT CONTACTS Right up =RP Right down =RN Right Open =RO	RP 39007	01	20
STEP 3	CABLE (conductor #1) Stripe up =SP Stripe down =SN	SN 39322	00	20
STEP 4	TIP-TO-TIP JUMPER LENGTH MilliMeters =MM Inches =IN	MM 700	DECIMAL 00	

NOTES: Where connector sizes are different, the inactive contacts will be located farthest from the cable stripe unless otherwise specified.

A P Products GmbH
Postfach 1158
D-71089 Weil im Schönbuch
Deutschland
Tel.: +49-7157-5348-0
Fax: +49-7157-5348-39
Web: www.ap-products.de
E-mail: info@ap-products.de

A P Products Ltd.
80 Cromwell Road
Saffron Walden, CB11 4BE
Great Britain
Tel.: +44-1799-526602
Fax: +44-1799-521408
Web: www.ap-products.co.uk
E-mail: info@ap-products.co.uk

A P Products S.r.l.
Viale Abruzzi, 87
I-20131 Milano
Italia
Tel.: +39-02-29404697
Fax: +39-02-29523280
Web: www.ap-products.com
E-mail: info-i@ap-products.com